

Cascaded warped-FIR and FIR filter structure for loudspeaker equalization with low computational cost requirements [☆]

Germán Ramos ^{a,*}, José J. López ^b, Basilio Pueo ^c

^a *Electronics Department, Technical University of Valencia, Camino de Vera s/n, 46022 Valencia, Spain*

^b *Audio and Communications Group, iTEAM, Technical University of Valencia, Camino de Vera s/n, 46022 Valencia, Spain*

^c *Polytechnic School, University of Alicante, Carretera San Vicente s/n, 03690 Alicante, Spain*

Available online 6 February 2008

Abstract

This paper proposes an improved filter structure and methodology for the equalization of loudspeakers and other audio systems. It employs a cascaded structure of a finite impulse response (FIR) filter and a warped-FIR filter in order to obtain the best performance of both types of filters. In the task of loudspeaker equalization, FIR filters achieve excellent resolution and equalization at high frequencies, but at low frequencies the resolution obtained is too poor when evaluated in a logarithmic frequency axis, that could only be improved using high order filters. To solve this lack of resolution at low frequencies, warped-FIR filters have been employed, but at the expense of decreasing the resolution of the filter at high frequencies and increasing the complexity of the filter structure and its computational cost. The proposed combination of both types of filters, combined with the correct selection of their orders, and the λ value for the warped-FIR filter, allows the FIR filter to maintain its good resolution at high frequencies and achieve enough resolution at low frequencies with the warped-FIR filter. In this way, lower order filters with lower computational cost could be obtained than when using FIR or warped-FIR only. This approximation attains a more uniform resolution of the filter when evaluated in octaves, behaving much more like human hearing, than the linear frequency resolution obtained when employing only FIR filters. © 2008 Published by Elsevier Inc.

Keywords: Loudspeaker equalization; Warped filters; FIR filters; Low computational cost

1. Introduction

Nowadays the use of digital filters for loudspeaker equalization is widely employed to improve their nonideal response. It is also possible to correct the electroacoustic path between the loudspeaker and the listener introduced by the listening room [1]. With today's low cost digital signal processors (DSP), it is feasible to achieve equalization of magnitude and/or phase responses with linear filtering, and even, to decrease the nonlinear distortion generated by loudspeakers employing nonlinear processing techniques [2,3].

The objective of a digital equalizer is both to filter the loudspeaker measured complex response $H_{\text{Ispk}}(j\omega)$ with the designed filter $H_{\text{filt}}(j\omega)$ and to approximate the filtered response at the measurement point $H_{\text{Ispk}}(j\omega)H_{\text{filt}}(j\omega)$ to the selected electroacoustic target response $H_{\text{target}}(j\omega)$. The designed filter must be defined then as the ratio between the target response $H_{\text{target}}(j\omega)$ and the measured loudspeaker response $H_{\text{Ispk}}(j\omega)$, as expressed in the equation

[☆] This filter structure, methodology, and apparatus to do the filtering are part of a patent pending.

* Corresponding author.

E-mail addresses: gramosp@eln.upv.es (G. Ramos), jjlopez@dcom.upv.es (J.J. López), basilio@ua.es (B. Pueo).

$$H_{\text{filt}}(j\omega) = \frac{H_{\text{target}}(j\omega)}{H_{\text{ispk}}(j\omega)}. \quad (1)$$

Depending on how $H_{\text{ispk}}(j\omega)$ is acquired and processed, several kinds of equalizations are possible. The acquisition of $H_{\text{ispk}}(j\omega)$ must be made using methods that provide the impulse response such as maximum length sequences (MLS) [4] or sweep signal [5]. In this way, an appropriate time windowing could be applied on the impulse response depending on the room's size or psychoacoustic criteria [6].

Usually, $H_{\text{ispk}}(j\omega)$ is obtained in front of the loudspeaker (on-axis measurement). In order to extend the equalization area, a weighted mean response could be created for several measurements at different angles, for example, at 0° , 15° , -15° , 30° , -30° in horizontal, and 15° , -15° in vertical.

If only magnitude equalization is required, a minimum phase equalizer could be designed, thus simplifying the filter design process. This is an usual approximation, because human hearing is more sensitive in the frequency response to distortions in the magnitude response than in the phase response. If a nonminimum phase equalizer is needed, then the designed filter $H_{\text{filt}}(j\omega)$ must be an approximation of Eq. (1) because of the mixed-phase nature of $H_{\text{ispk}}(j\omega)$ when it is measured in a listening room, which usually has nonminimum phase behavior. Therefore, $H_{\text{ispk}}(j\omega)^{-1}$ is unstable and an approximation must be carried out.

The electroacoustic target response must be defined in a reasonable way. It must respect the band-pass characteristic of the transducer, the loudspeaker. If a flat target response in magnitude is desired, $|H_{\text{target}}(j\omega)| = H_{\text{target}}(\omega) = 1$, the filter approximates the inverse of the measured magnitude loudspeaker response at the listening point $H_{\text{ispk}}(\omega)^{-1}$. In theory this equalization would provide a loudspeaker with an ideal frequency response at the measurement point. The equalization filter tries to correct the natural band-pass frequency response of the loudspeaker, introducing excessive gain at low and high frequencies where the loudspeaker does not work, thus generating distortion due to excessive displacement of the cone, ringing, and also increasing the electrical power dissipated on the voice-coil, problems that could even damage the loudspeaker. A band-pass target function with low frequency near the resonance frequency of the loudspeaker in the box is recommendable to avoid these effects. More details about target responses selection, measurements and processing techniques of the responses can be found in [6–9].

For the task of loudspeaker equalization, several digital filter design methods have been proposed over the last few years which could mainly be classified in the two great families of digital filters: FIR filters [1,10], and infinite impulse response (IIR) filters [6,8,11]. To improve the resolution of the FIR and IIR filters at low frequencies, and/or to obtain a frequency resolution closer to psychoacoustic scales like the Bark or equivalent rectangular bandwidth (ERB) scales, warped and Kautz filter structures have also been proposed [6,7,12,13].

The objective of this paper is to develop an improved filter structure and methodology for the equalization of loudspeakers and other audio systems that requires low computational cost, introduces low latency, and obtains a filter with enough frequency resolution on the whole audio frequency band. To accomplish these objectives, a digital filter composed of a warped-FIR and a FIR filter in cascade is proposed. This exploits the benefits of both kinds of filters: FIR filters offer excellent resolution at high frequencies and easy implementation; meanwhile warped-FIR filters can achieve good resolution at low frequencies. With this structure and a proper selection of the warping parameter λ and the order of each filter, it is possible to obtain a digital equalizer with better resolution when evaluated over a logarithmic frequency axis, and lower computational cost needs than when employing FIR or warped-FIR filters alone.

The paper is organized as follows. Section 2 presents the results obtained when employing FIR and warped-FIR filters alone for loudspeaker equalization, with a more in depth description of warped filters and their properties. The proposed filter structure is described in Section 3, where a study of the obtained filter resolution is made. In Section 4, a detailed example of application of the proposed filter is carried out, and it is compared with the equalization achieved when using FIR or warped-FIR filters alone, for the same computational cost. Finally, Section 5 presents the conclusions.

2. FIR and warped-FIR filters for loudspeaker equalization

2.1. FIR filters

The use of FIR filters in equalization is widely employed due to their inherent advantages. FIR filters are straightforward to design and implement, they are always stable, and can correct the magnitude and phase responses, if desired, at the same time. Its design could be done in the frequency domain or in the time domain. In the frequency

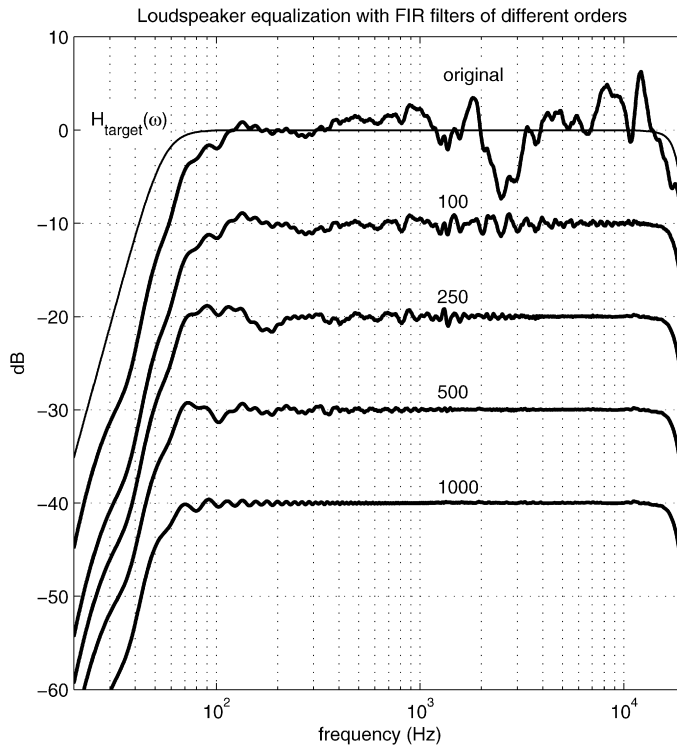

Fig. 1. Loudspeaker equalization with FIR filters of orders 100, 250, 500, and 1000 (scaled 10 dB).

domain, the easiest filter design method is the inversion of the Fourier transform of the desired filter response [14]. Improvements on this method are achieved when using regularization [10] before obtaining the inverse of the Fourier transform. In the time domain, the least squares approximation has also been proposed by Mourjopoulos [1].

Fig. 1 shows the equalization results of a two-way passive loudspeaker with an 8" woofer in bass-reflex configuration for the low frequencies, and a 3/4" tweeter for the high frequencies. In this example the equalization FIR filters have been designed by least squares in the time domain [1]. The upper graph centered at 0 decibels (dB) shows the unfiltered loudspeaker magnitude response (original) $H_{\text{spk}}(\omega)$, and the selected electro-acoustic magnitude target response $H_{\text{target}}(\omega)$ in thin line. In this case a target with a fourth-order high-pass Butterworth filter at 55 Hz, and a second-order low-pass Butterworth at 18 kHz, has been selected. This target response, as previously mentioned, respects the natural band-pass characteristic frequency response of the loudspeaker, extending its low frequency response in a reasonable way without introducing excessive gain in the filter's response. FIR filters of 100, 250, 500, and 1000 taps have been designed, and the equalizations obtained are displayed below the original response, scaled 10 dB down each one from the other for clarity. The equalization achieved at high frequencies is excellent for all orders, but at low frequencies, the equalization obtained for 100, 250, and 500 coefficients, clearly differs from the target response. Even for 1000 coefficients, some ripple appears in the response. It is clear that as the order of the filter increases, the equalization at lower frequencies improves.

The poor resolution evaluated on a logarithmic frequency axis at low frequencies of the FIR filters is due to the linear treatment of the axis in the design and implementation of the filter; it is done either in the time or the frequency domain. The frequency resolution of a FIR filter Δf_{FIR} is defined approximately as the ratio of the sampling frequency f_s and the order of the filter N , as it is shown in the equation

$$\Delta f_{\text{FIR}} = \frac{f_s}{N}. \quad (2)$$

With a sampling frequency of 48 kHz, for order 100 the resolution is 480 Hz, for 250 is 192 Hz, for 500 is 96 Hz, and for 1000 is 48 Hz. For loudspeaker equalization, those resolutions are enough for high frequencies, but not for low frequencies, where resolutions as low as 5 Hz (or even lower for subwoofers) are necessary. To achieve that degree of

resolution, filters of orders above 10,000 are needed. The implementation in real time of filters of those orders requires huge computational cost when implemented in the time domain. To reduce the computational cost, it is feasible to carry out the filtering in the frequency domain using FFT, but at the expenses of increasing the latency that is not permissible in live applications where delays above 10 milliseconds are noticeable and annoying to the speakers and musicians [15]. The same problem with the latency introduced by the filter occurs when performing multi-rate filtering [16], due to the necessary processes of decimation and interpolation, even when employing poly-phase filter structures.

From a subjective and psycho-acoustic point of view, the inherent linear treatment of the frequency axis of FIR filters is not a good choice. Human hearing behaves more logarithmically, on the frequency axis as well as on the magnitude axis. Subjectively speaking, the spectral distance (difference between the target response and the filtered loudspeaker response) between 1 and 2 kHz is of similar significance to the one between 10 and 20 kHz. Following this behavior, psychoacoustic scales like the Bark and ERB [7] have been designed, and for frequencies above 500 Hz, their behavior is more similar to a logarithmic curve than to a linear curve. In order to measure psycho-acoustically the spectral distance and to subjectively evaluate the quality of the equalization, an estimator $e_{\log\text{-dB}}$ was defined and verified in [6]. It performs as follows. The frequency axis is discretized logarithmically to form the vector ω_{\log} of Eq. (3) with a resolution of 1/48th of octave, obtaining 576 frequencies between 5 and 20 kHz which is enough for equalization proposes.

$$\omega_{\log} = [\omega_0 \ \omega_1 \ \omega_2 \ \dots \ \omega_{N-1}]. \quad (3)$$

The error vector of Eq. (4) represents the difference between the target response and the filtered loudspeaker response, all magnitudes evaluated in dB and over the discrete frequency vector ω_{\log} .

$$e(\omega_{\log})_{\text{dB}} = H_{\text{target}}(\omega_{\log})_{\text{dB}} - H_{\text{lspk}}(\omega_{\log})_{\text{dB}} - H_{\text{filt}}(\omega_{\log})_{\text{dB}}. \quad (4)$$

The expression of the estimator $e_{\log\text{-dB}}$ is shown in Eq. (5) where n_i and n_f are the indexes of ω_{\log} to the initial and final frequencies where the error is evaluated. It represents the mean absolute error in dB between the desired target response and the filtered one evaluated over a logarithmic frequency axis.

$$e_{\log\text{-dB}} = \frac{1}{n_f - n_i + 1} \sum_{k=n_i}^{n_f} |e(\omega_{\log}[k])_{\text{dB}}|, \quad (5)$$

where $\omega_{\log}[k]$ represents the element k of the vector ω_{\log} (3).

Fig. 2 displays the error responses as defined in Eq. (4) for the equalizations with the FIR filters shown in Fig. 1, also scaled 10 dB for clarity. On the right of each curve, the measured value of $e_{\log\text{-dB}}$ is shown. The upper curve is the difference between the target response and the original loudspeaker response without filtering. The unfiltered mean error $e_{\log\text{-dB}}$ is 3.09 dB. With a FIR filter of 100 taps (the second curve), the error for the high frequencies above 5 kHz is very small, but at low frequencies the error reaches up to 12 dB at 40 Hz. The value of $e_{\log\text{-dB}}$ goes down to 2.02 dB. With 250 taps, the equalization is excellent for frequencies above 2 kHz, but at 40 Hz, the error still reaches 8 dB, obtaining an error value $e_{\log\text{-dB}}$ of 1.06 dB. With 500 taps, $e_{\log\text{-dB}}$ decreases to 0.42 dB, the nearly perfect equalization being from 400 Hz to 20 kHz. Finally with 1000 taps, $e_{\log\text{-dB}}$ decreases to 0.23 dB, existing a residual lobbing error in the response at low frequencies that reaches at a maximum of 1.95 dB. The problem of the FIR filters to equalize the low frequencies is clearly noticed at the error responses. Psychoacoustic studies about perception [17] have determined that an error below ± 1 dB from the target response is not detectable by most humans when listening conventional music or voices. In this example, even with 1000 taps, that small deviation from the target is not reached.

2.2. Warped-FIR filters

Digital frequency warping is achieved when the unit delay elements in a digital filter structure are replaced by first-order all-pass filters. It was initially proposed by Oppenheim et al. [18] to obtain a nonuniform frequency resolution analysis with the Fourier transform. In digital filters, the use of the all-pass filters instead of the unit delay elements was first proposed by Strube [19]. The first-order all-pass filter is given by $A(z)$ of Eq. (6) where λ is the warping parameter. The structure of a warped-FIR filter is displayed in Fig. 3a where the delay elements z^{-1} are substituted by the first-order all-pass filters $A(z)$. Fig. 3b shows the structure with the internal scheme of $A(z)$, and finally, Fig. 3c shows the optimized warped-FIR filter structure proposed by Karjalainen at [7], that saves memory and operations.

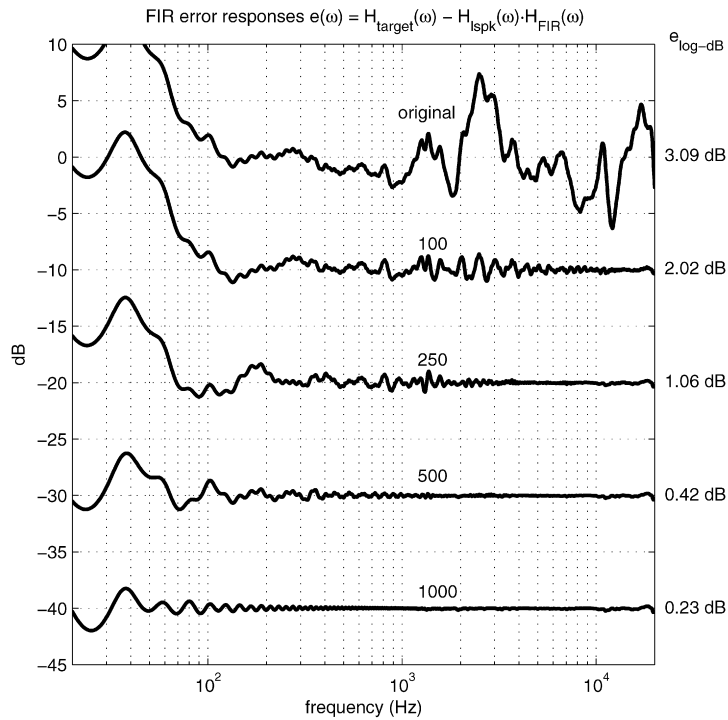

Fig. 2. Error responses (scaled 10 dB) and $e_{10\text{log-dB}}$ value.

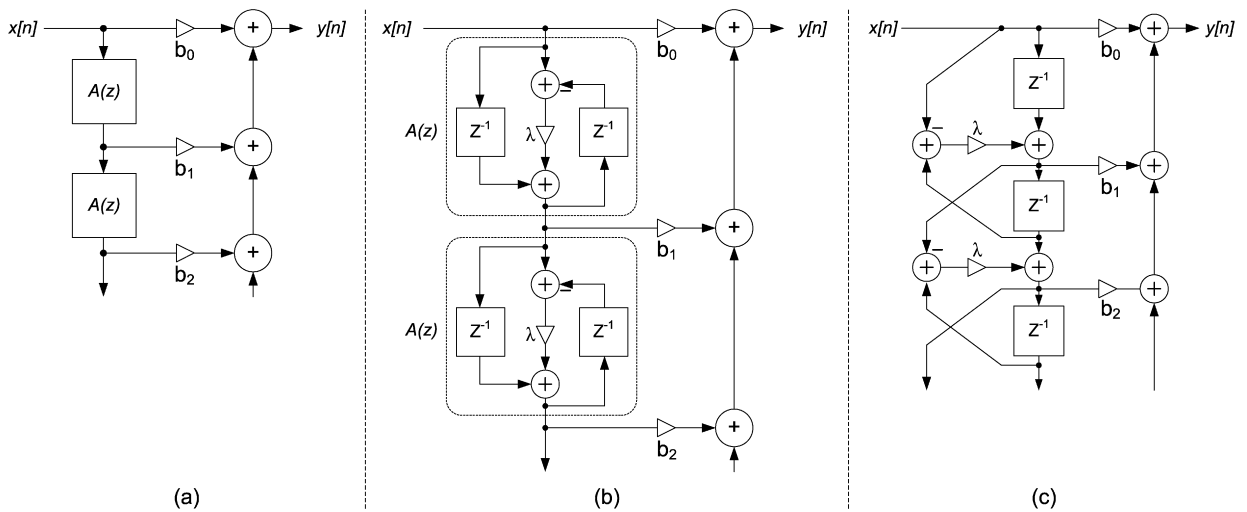

Fig. 3. (a) Warped-FIR filter structure, (b) structure with $A(z)$ expanded, (c) optimized structure proposed at [7].

The transfer function of the warped-FIR filter is $H_{\text{WFIR}}(z)$ in Eq. (7). Warped filtering is not a method for designing filters, it is an structure that produces the effect of warping the frequency axis. The filter could be designed using any of the well-known filter design methods.

$$A(z) = \frac{z^{-1} - \lambda}{1 - \lambda z^{-1}}, \tag{6}$$

$$H_{\text{WFIR}}(z) = \sum_{i=0}^{N-1} b_i A(z)^i = \sum_{i=0}^{N-1} b_i \left(\frac{z^{-1} - \lambda}{1 - \lambda z^{-1}} \right)^i. \tag{7}$$

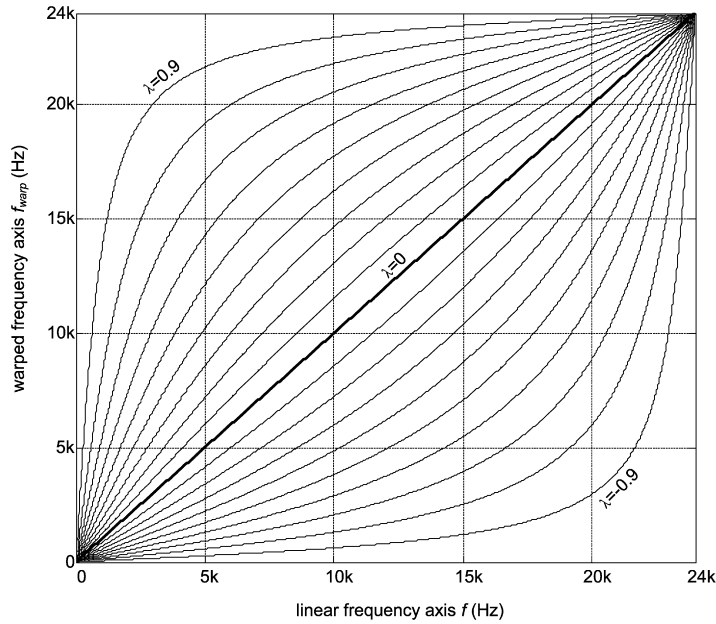

Fig. 4. Warping effect for $\lambda = -0.9-0.9$ with $f_s = 48$ Hz.

The substitution of z^{-1} by $A(z)$ generates the warping of the frequency axis [18] that is a function of the phase response of $A(z)$. For a given sampling frequency f_s , the new frequency axis after the mapping is $f_{\text{warp}}(f, f_s, \lambda)$ of the equation

$$f_{\text{warp}}(f, f_s, \lambda) = \arg(A(z)) = f + \frac{f_s}{\pi} \arctan\left(\frac{\lambda \sin(2\pi f/f_s)}{1 - \lambda \cos(2\pi f/f_s)}\right). \tag{8}$$

Fig. 4 shows the frequency mapping due to the warping effect. For positive values $0 < \lambda < 1$, the frequency axis is compressed to the high frequencies, and for negative values $-1 < \lambda < 0$, it is compressed to the low frequencies. For $\lambda = 0$ there is no warping effect and $A(z) = z^{-1}$, a simple delay element.

To deal with the lack of resolution at low frequencies of FIR filters, warped filters have been employed for loudspeaker equalization with positive values of λ to move up the low frequencies and achieve a better resolution. Karjalainen proposed its use with FIR and with IIR filters at [20] where a realizable IIR structure was presented, and Härmä at [21]. Comparisons of warped-FIR and warped-IIR filters for loudspeaker equalization were presented in [7]. Recently, the use of Kautz filters (that could be interpreted as a generalization of warped filters) has been also proposed in [13] for loudspeaker and room equalization. Other interesting references about warped filtering are [22] where the use of warped filters for low frequency equalization was mentioned.

The frequency resolution obtained with warped-FIR filters, Δf_{warp} , is obtained as the resolution of the equivalent FIR filter multiplied by the derivative of f_{warp} with respect to the frequency, as shown in the equation

$$\Delta f_{\text{warp}}(f, f_s, \lambda) = \frac{f_s}{N} \frac{1 + \lambda^2 - 2\lambda \cos(2\pi f/f_s)}{1 - \lambda^2}. \tag{9}$$

Fig. 5 represents the relative warped frequency resolution versus the linear frequency resolution. For positive λ values the frequency resolution increases at low frequencies, but decreases at high frequencies. For negative λ values the other way around. As λ gets bigger toward one, an improvement of the resolution at low frequencies is obtained, but the loss of resolution at high frequencies starts early and gets worse. The frequency where the resolution of the warped scale equals the linear scale is the turning point frequency f_{tp} and its value is given by Eq. (10). In [12] Smith and Abel developed an expression to determine the λ value that better approximate the Bark and ERB psychoacoustic scales (for $f_s = 48$ kHz, λ_{Bark} is 0.766).

$$f_{\text{tp}} = \frac{f_s}{2\pi} \arccos(\lambda). \tag{10}$$

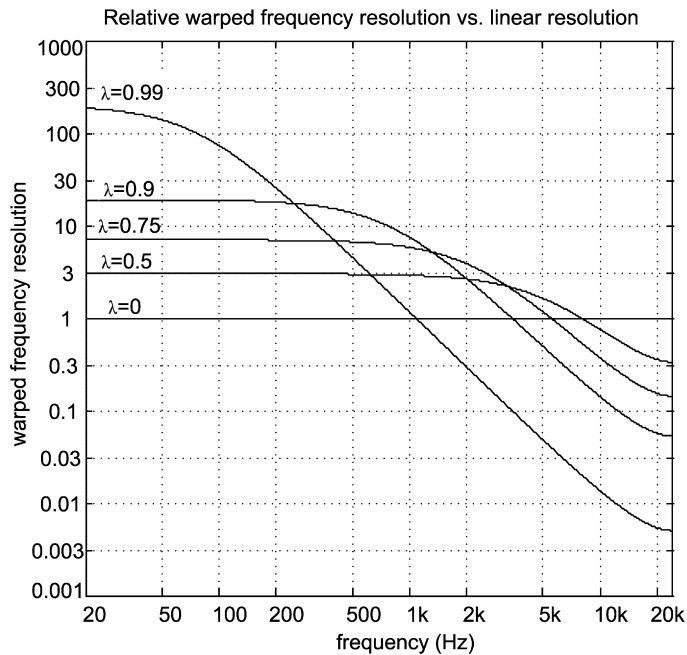

Fig. 5. Relative warped frequency resolution vs linear resolution (with $f_s = 48$ kHz).

As can be seen in Figs. 3b and 3c, a warped-FIR filter requires more computational cost with respect to a FIR filter for the same order. Depending on the architecture of the DSP or microprocessor employed, its computational cost increases by a factor of between 3 and 4 [7] with respect to a FIR filter. Nevertheless, warped-FIR filters can reduce the order of the filter by a factor up to 5, so its use could be computationally efficient. Assuming a penalty factor of 3, the same FIR filter equalizations done in Fig. 1 have this time been carried out with warped-FIR filters, but with one third of the FIR filter orders to maintain the same computational cost. In this case, a λ value of 0.766 has been employed to achieve a resolution close to the Bark scale. The equalizations are shown in Fig. 6 scaled 10 dB for clarity, and the error responses and the $e_{\log\text{-dB}}$ value are shown in Fig. 7. With 33 taps, the warped-FIR filter achieves an error value $e_{\log\text{-dB}}$ of 1.29 dB, better than the 2.02 dB obtained with the 100 taps FIR filter. Although the equalization at high frequencies is clearly worse due to the reduction of resolution, the equalization at low and mid frequencies is better as it can be seen in the error curves of Figs. 2 and 7. The error goes down to 0.77 dB with 83 taps instead of the 1.06 dB obtained with the 250 taps FIR filter. The error is within the ± 1 dB band from 200 Hz to 20 kHz. For 167 taps $e_{\log\text{-dB}}$ value is only 0.12 dB, even better than the equalization achieved with the FIR filter of 1000 taps (0.23 dB). Finally with 333 taps, the result is excellent, with a residual error of only 0.03 dB. For the selected λ value, the maximum resolution of the warped-FIR filter is obtained around 2 kHz, getting worse for lower and upper frequencies.

With this comparison, it is clear that the use of warped filters for loudspeaker equalization can be computationally efficient, spreading the resolution of the designed filter taking into account psychoacoustic aspects of human hearing. For the same computational cost, better equalizations could be achieved with the use of warped structures, or lower computational cost is needed to for the same quality of the obtained equalization. These conclusions are also commented at [7].

3. Proposed filter structure and design

3.1. Filter structure

After the analysis of the results obtained in Section 2 (the comparison of the loudspeaker equalization with FIR filters and warped-FIR filters), two main conclusions are arrived at. First, FIR filters achieve excellent resolution at high frequencies while having a simple structure and only one multiply and accumulate (MAC) operation per tap is required, however, at low frequencies, the achieved resolution is too poor, and high order filters are necessary.

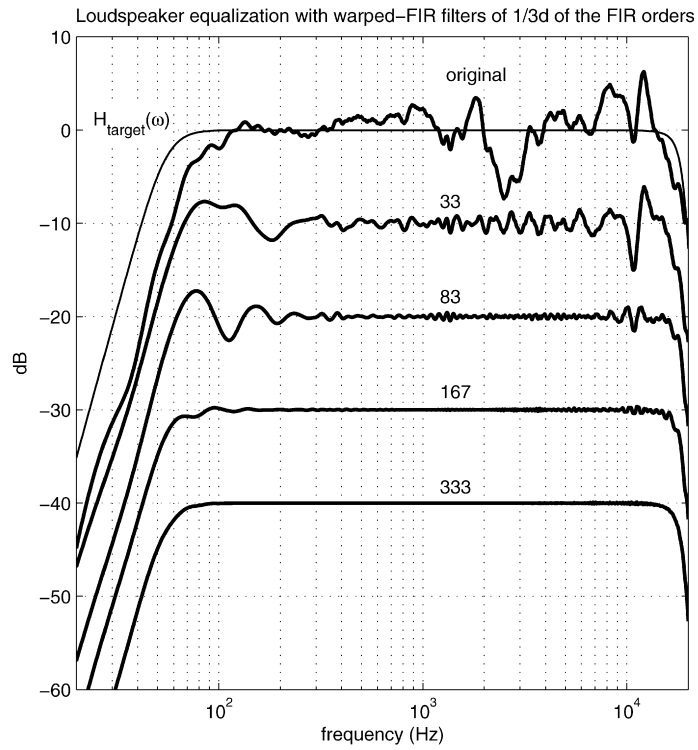

Fig. 6. Warped-FIR equalization with 1/3rd-order filters respect the FIR filters ($\lambda = 0.766$, $f_s = 48$ kHz).

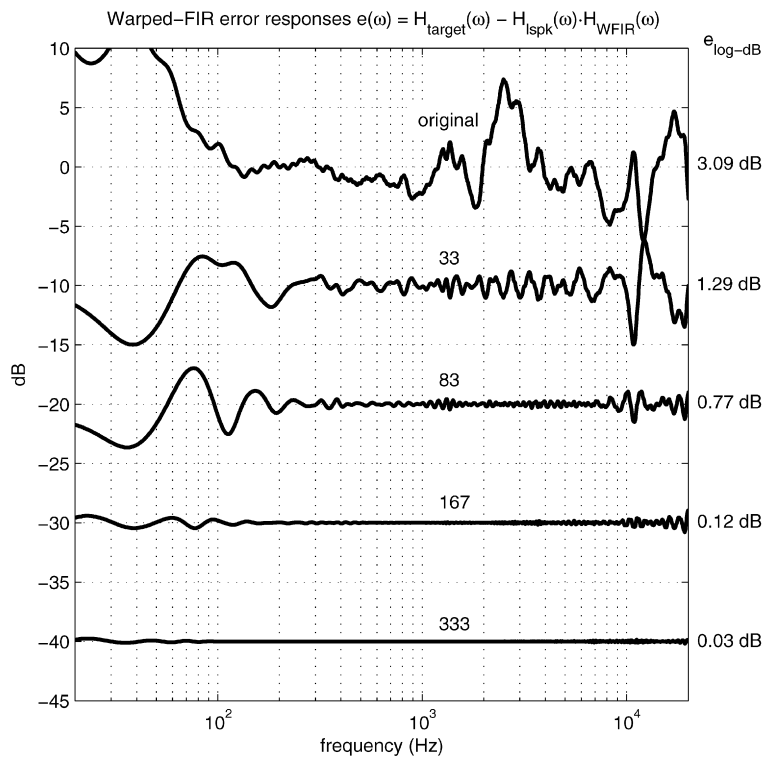

Fig. 7. Warped-FIR error responses and $e_{\text{log-dB}}$ value.

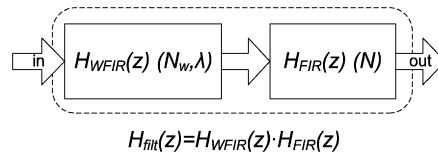

Fig. 8. Proposed filter structure.

Second, warped-FIR filters could improve the frequency resolution at low and mid frequencies at the expense of losing resolution at high frequencies and increasing the complexity of the filter in a factor between 3 and 4.

In order to get the advantages of FIR filters and warped-FIR filters, maintaining a low computational cost, the filter structure shown in Fig. 8 is proposed.

The equalizer filter $H_{\text{filt}}(z)$ is the cascade of a warped-FIR filter $H_{\text{WFIR}}(z)$ of order N_w and warping parameter λ , and a FIR filter $H_{\text{FIR}}(z)$ of order N . The FIR filter will equalize the high and mid-high frequencies; meanwhile the warped-FIR filter will focus its effort in the low and mid-low frequencies. To achieve this, a correct selection of the λ value must be made to maximize the resolution of the combined filter on the whole frequency band. The equivalent filter order N_{MAC} (in terms of computational cost or MACS) could be approximate as

$$N_{\text{MAC}} = N + 3N_w \tag{11}$$

where a penalty of a factor 3 has been taken for the warped-FIR filter. To reduce the computational cost of the filter, the order of the warped-FIR filter must be as low as possible; since it requires 3 times the number of MACS than the FIR filter.

3.2. Filter resolution and λ value selection

The frequency resolution of the proposed filter $H_{\text{filt}}(z)$ will be a combination of the linear resolution of the FIR filter $H_{\text{FIR}}(z)$, Eq. (2), and the nonlinear resolution of the warped-FIR filter $H_{\text{WFIR}}(z)$, Eq. (9). As explained in Section 2.2, the relative warped-FIR filter resolution regarding the resolution of a FIR filter of the same order was shown in Fig. 5.

Fig. 9a displays the frequency resolution of FIR and warped-FIR filters in terms of the corresponding Q -value. This Q -value resolution is defined as the quotient between the frequency under consideration and the frequency resolution of the filter at that frequency (also employed in [7]), as Eq. (12) shows.

$$Q = \frac{f}{\Delta f}. \tag{12}$$

For a linear FIR filter, the Q -value resolution is

$$Q_{\text{FIR}} = \frac{f}{\Delta f_{\text{FIR}}} = \frac{f}{f_s/N} \tag{13}$$

and for the warped-FIR filter is

$$Q_{\text{WFIR}} = \frac{f}{\Delta f_{\text{warp}}(f, f_s, \lambda)}. \tag{14}$$

In Fig. 9b, other representation of the resolution is plotted, but now in terms of the bandwidth resolution in octaves (BW_{oct}). It is directly related with Q through the expression (15) valid for high Q values.

$$\text{BW}_{\text{oct}} = \frac{1}{Q \ln(2)}. \tag{15}$$

Figs. 9a and 9b are evaluated over logarithmic axis, both abscissa and ordinate. In this way, the measurement obtained will consider the natural behavior of human hearing, and it will judge the frequency resolution of the filters from a psychoacoustic point of view.

The resolution of the FIR filter, as shown in the figure, is constant with a bandwidth of 100 Hz which correspond to a filter order of 480 when using a sampling frequency $f_s = 48$ kHz. The resolution of the warped-FIR filter corresponds to a warped filter of order 480. These resolutions are also compared with a constant resolution of 1/3rd-octave, and with the frequency resolution of the Bark scale. From a psycho-acoustic point of view, the comparison of the

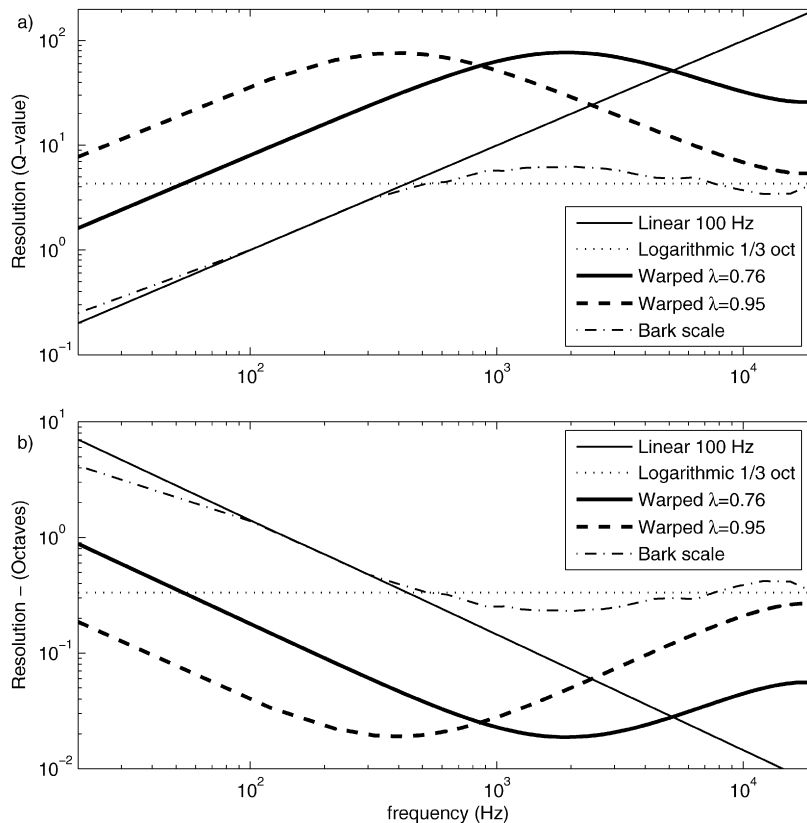

Fig. 9. Filter resolution curves: FIR linear resolution (100 Hz, 480 taps at $f_s = 48$ kHz), logarithmic resolution (1/3 octave), warped-FIR (480 taps, 0.76 and 0.95 λ values), Bark scale. Evaluated in (a) Q -value, (b) octaves.

resolution of warped filters with the Bark scale is very interesting, because it follows the resolution bandwidth of the human auditory system using the concept of critical bands [12].

For the FIR filter, the Q -value (and its logarithmic resolution) increases with the frequency as seen in Fig. 9 for the linear case. The dashed thin lines represent the resolution of a 1/3rd-octave scale that is constant with the frequency. Its Q value is 4.32, and its octave value is obviously 1/3. It is approximately the resolution obtained with a 1/3rd-octave graphic equalizer that for frequencies below 430 Hz, it is even better than the one obtained with the 480 taps FIR filter. The dash-dot thin lines are the resolutions of the Bark scale calculated from the published frequencies [12]. Up to 500 Hz, its resolution is 100 Hz constant, like the FIR filter of the example. Above 500 Hz its behavior is more logarithmic, similar to the 1/3rd-octave, arriving up to a maximum resolution close to 1/5th octave ($Q = 6.3$) at 2 kHz.

The solid thick line represents the frequency resolution of the warped-FIR filter of 480 taps with a λ value of 0.76 that corresponds to the value that better fits the Bark scale (for $f_s = 48$ kHz), and is the one used on the warped-FIR equalizations of Fig. 6. It follows the shape of the Bark scale (with better resolution), with maximum Q -value resolution close to 2 kHz as was shown in Figs. 6 and 7. Finally, the dashed thick line represents the resolution of the same warped-FIR filter of 480 taps, but with a $\lambda = 0.95$. For both warped filters, the maximum Q is the same, but the frequency with better resolution decreases from 2 kHz ($\lambda = 0.76$) to 350 Hz ($\lambda = 0.95$). Also, the resolution at low frequencies has been improved 4.5 times in the second case, the same factor that the resolution has been decreased at high frequencies.

The Q -value and octave resolution graphs of the two warped-FIR filters of Fig. 9 demonstrate that with a proper selection of the λ value it is possible to select the frequency band where the warped-FIR filter achieves the best resolution. In other words, it is possible to *tune* the resolution of the filter. In the filter structure proposed in this paper for loudspeaker equalization using low order warped-FIR filters is effective for reducing its computational cost, with λ values greater than 0.9 to achieve resolution at low frequencies. The higher the λ value (up to 1), the lower frequency with maximum Q -resolution, the higher low frequency Q -resolution, and the lower high frequency Q -resolution.

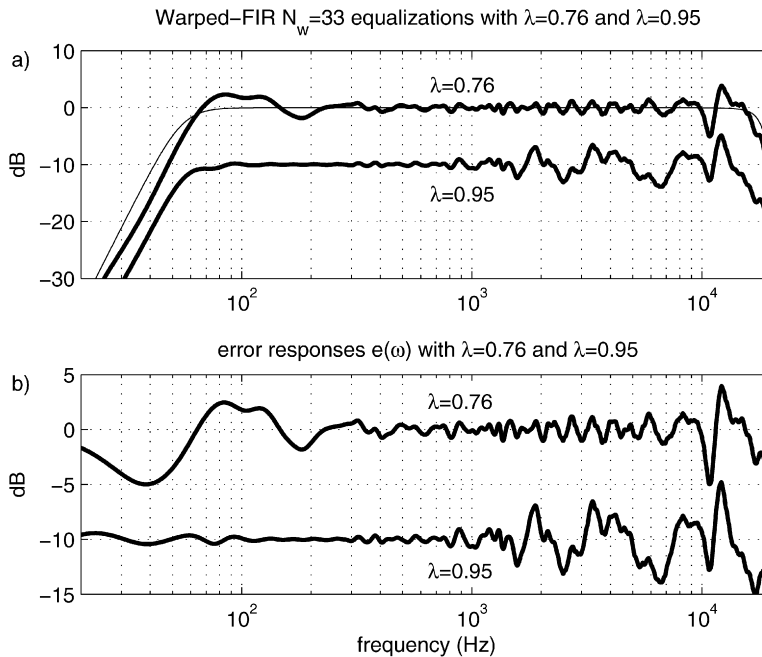

Fig. 10. Warped-FIR equalizations of order $N_w = 33$ with $\lambda = 0.76$ and 0.95 (scaled 10 dB). (a) Equalization responses, (b) error responses.

In order to better understand the effect of λ value variation, an example has been carried out. The loudspeaker used previously has been equalized with two filters of order $N_w = 33$ and λ values of 0.76 and 0.95. Its results are displayed in Fig. 10a. As noted previously, with $\lambda = 0.76$ the maximum resolution of the filter is around 2 kHz, obtaining poor equalization at low and high frequencies. When employing $\lambda = 0.95$ (centered at -10 dB for clarity) the equalization of the low frequencies has been improved at the expense of making the equalization of the high frequencies worse. Now the maximum resolution of the filter is around 350 Hz, achieving an error below ± 1 dB from 20 Hz to 1.5 kHz with only 33 taps, with a computational cost equivalent to a 100 taps FIR filter. The error responses of the two equalizations are displayed in Fig. 10b where one can see how the maximum resolution of the filters changes with the two λ values.

In order to facilitate the selection of the appropriate λ value, the frequency of the maximum Q -resolution as a function of λ is represented for different sampling frequencies: 44.1, 48, 88.2, and 96 kHz. The graphs of Fig. 11a display these results between 20 Hz and 6 kHz for λ values from 0.7 to 1. The leftmost curve corresponds to f_s of 44.1 kHz, and the rightmost to 96 kHz. With these graphs it is straightforward to choose the value of λ to ‘tune’ in frequency the effort of the warped-FIR filter. Fig. 11b is the same graph detailed between 20 Hz and 1 kHz, and λ from 0.9 to 1. These graphs have been obtained numerically looking for the maximum of Q -resolution as a function of λ for the four standard sampling frequencies.

The selection of the three parameters (size of the FIR filter N , size of the warped-FIR filter N_w , and λ value for the warped-FIR filter) for a specific loudspeaker equalization, is a trade-off between the demand of equalization at low frequencies (for N_w and λ selection), and at mid and high frequencies (for N). Moreover, this selection is highly dependent on the loudspeaker frequency response behaviour and the specified target response, so there is not possible to formulate a general rule for all the cases.

3.3. Methodology for the design of the two-stage filter

The design of the proposed equalization filter requires the joint design of the FIR filter of order N , and the warped-FIR filter of order N_w and warping parameter λ . To maintain the low computational cost requirement, the warped filter order must be as low as possible.

First, the first stage (warped-FIR) must be designed. As mentioned previously, this stage focuses its effort in equalizing the low frequencies. The selection of the λ value that provides the best equalization depends on two

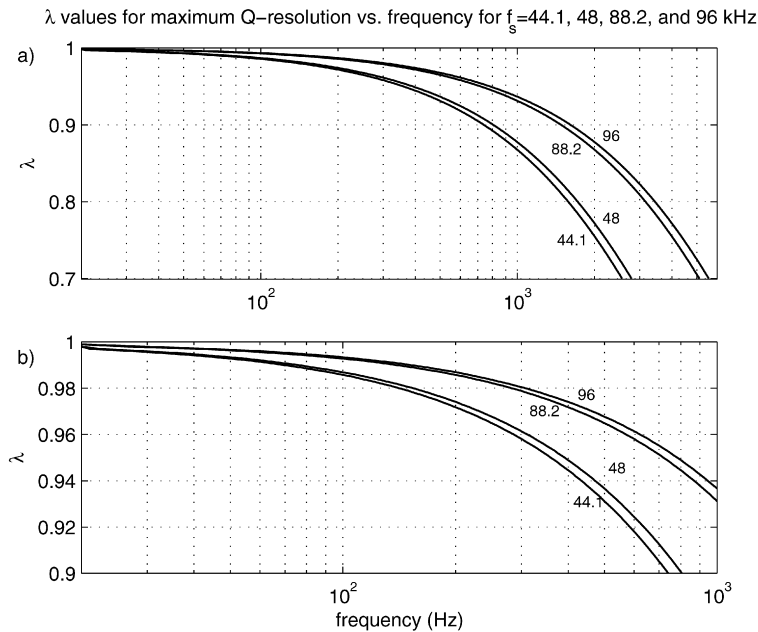

Fig. 11. (a) λ values for maximum Q -resolution a function of the frequency for $f_s = 44.1, 48, 88.2,$ and 96 kHz. (b) Detail for λ between 0.9 and 1.

factors: the lowest frequency to be corrected (i.e., subwoofers) and the order of the second stage (FIR) that conditions its lower frequency resolution and hence the link point between them.

Second, the second stage (FIR) filter must be designed from the loudspeaker response filtered by the first stage. This second stage will correct the response mainly in the high frequencies where the first stage has less resolution. This FIR filter does not have to correct the low frequencies because they have been corrected previously by the first stage. However, in certain cases, the FIR filter will introduce some ripple on the frequency response at low frequencies (as shown in Fig. 1) making the equalization obtained with the warped-FIR filter worse. To avoid this effect it is possible to pre-process the frequency response at low frequencies and force it to be flat up to a selected frequency. It is recommendable to define a transition frequency band between the flat response and the unprocessed one to avoid a hard edge on the processed frequency response that cause undesired ripple on the response.

The order of the two filters is related to the precision demanded in the equalization and it is conditioned with the available computational cost. Fig. 10 shows the results that can be achieved for the loudspeaker under test for the warped-FIR. Using $N_W = 33$ and $\lambda = 0.95$ it is possible to achieve an error below ± 1 dB up to 1.5 kHz. In Fig. 2 it is shown that it is also possible to achieve an error below ± 1 dB for the high frequencies (1.5–20 kHz) with a FIR filter of order N between 100 and 150. According to Eq. (11), this will give a computationally equivalent filter order N_{MAC} from 200 to 250, with a residual equalization error below ± 1 dB in the whole frequency audio band. In order to achieve this degree of equalization a FIR filter of more than 1000 taps is needed (Fig. 2). With warped topology, a warped-FIR of order $N_W = 167$ ($N_{MAC} = 500$) is needed (Fig. 7). Therefore, a huge amount of computational cost saving can be achieved using the proposed topology compared to a pure FIR or pure warped-FIR filters topologies.

The design of $H_{fit}(z)$ is a trade-off among different factors: the order of the FIR filter N (and the lower frequency that is able to equalize), the order of the warped-FIR filter N_W (and its computational cost), and the warping parameter λ . Its value must be selected to achieve enough resolution at low frequencies and at the same time to reach resolution at the frequencies where the FIR filter does not equalize properly. These details can be better understood from the equalization examples of the next section.

4. Examples of application and comparatives

In this section, the proposed filter structure and filter design methodology will be validated through two examples. First, the same loudspeaker equalized in the previous sections with FIR and warped-FIR filters will be equalized with the proposed filter structure. Second, another loudspeaker with different irregularities will be also equalized.

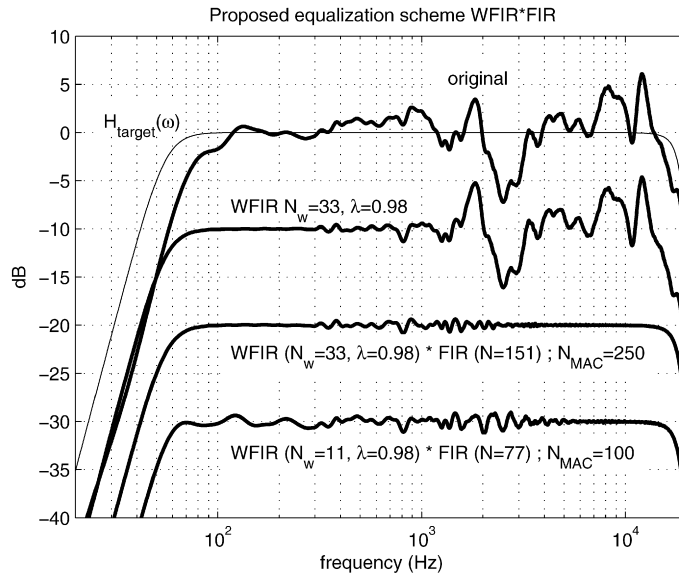

Fig. 12. Equalization achieved with the presented filter structure for $N_{MAC} = 250$ and 100.

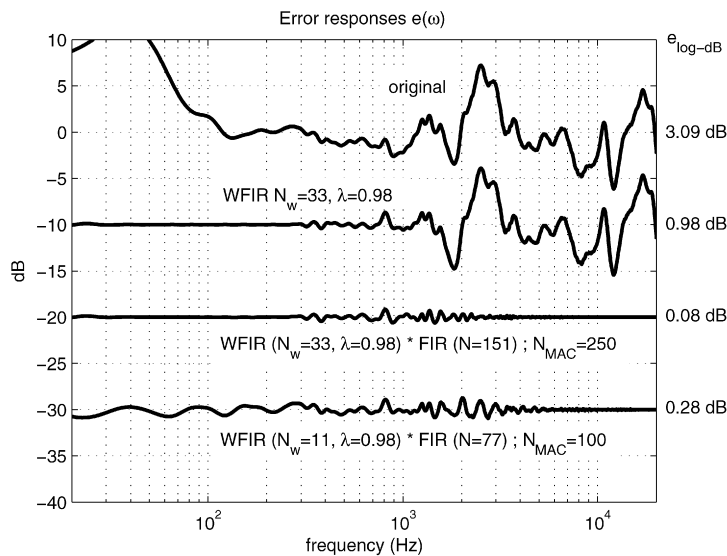

Fig. 13. Error responses and $e_{\log-dB}$ values obtained with the presented filter structure for $N_{MAC} = 250$ and 100.

4.1. First example

The frequency response of the loudspeaker to be equalized is represented with a thick line over the 0 dB level in Fig. 12. The target frequency response $H_{target}(\omega)$ is represented by a thin line also over the 0 dB level. It is the same target response used in Section 2: fourth-order high-pass Butterworth at 55 Hz, and second-order low-pass Butterworth at 18 kHz. The original error response is in Fig. 13 with an initial error $e_{\log-dB}$ of 3.09 dB. It has a maximum error of 12 dB at 40 Hz and several peaks and dips of more than 4 dB over the whole audio band. The results of the equalizations are shown in Fig. 12, and the error graphs and the $e_{\log-dB}$ values are shown in Fig. 13.

Using the proposed structure, a filter of equivalent order $N_{MAC} = 250$ is going to be designed, composed of a warped-FIR filter of order $N_w = 33$, and a FIR filter of order $N = 151$. The first step in the design of the proposed filter is to design the warped-FIR filter with a λ value selected to achieve enough equalization at lower frequencies. In

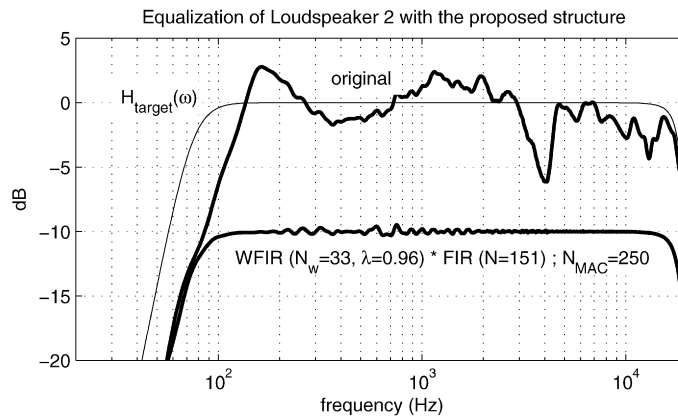

Fig. 14. Equalization of loudspeaker 2 with $N_{MAC} = 250$ ($N_W = 33$, $\lambda = 0.96$, $N = 151$).

this case, a value of 0.98 has been used, which corresponds to a frequency with maximum resolution of 150 Hz when employing a sampling frequency $f_s = 48$ kHz, as can be observed in Fig. 11b. With these values of N_W and λ , the equalization achieved is the one shown in Fig. 12 over the -10 dB level (scaled -10 dB for clarity in the graph), being the equalization quite good up to 700 Hz (with an order of only $N_W = 33$). The error curve is shown in Fig. 13 and is below ± 0.4 dB up to 700 Hz, and the $e_{\log-dB} = 0.98$ dB. Once the warped-FIR filter is designed, the FIR filter of order $N = 151$ is designed from the warped-FIR filtered response. The combined equalization achieved is displayed over the -20 dB level in Fig. 12, and the residual error in Fig. 13 with a very low error value, $e_{\log-dB} = 0.08$ dB. The FIR filter corrects the response at high frequencies down to 2.5 kHz excellently, with an error curve below ± 0.1 dB. Between 700 Hz and 2.5 kHz, the equalization is worse, but the error is always within ± 0.8 dB. This is the frequency band in which neither the warped-FIR nor the FIR filter achieve enough resolution with the selected filter orders. But from a practical point of view (subjectively speaking), the equalization obtained will not be distinguishable from a better one by the majority of listeners, as reported by several experiments dealing with human hearing [17].

If an error curve within ± 1 dB in the whole audible audio band (20 Hz to 20 kHz) is tolerable for equalization purposes, the equivalent filter order N_{MAC} could even be reduced to only 100, with $N_W = 11$ and $N = 77$. The equalization obtained and error responses are over the -30 dB level lines in Figs. 12 and 13 with an $e_{\log-dB} = 0.28$ dB. With the proposed filter, it is possible to achieve that degree of equalization with a computational cost of only 100 MACs per sample, obtaining a more uniform frequency resolution of the filter, when evaluated over a logarithmic frequency axis, than the one obtained when employing only FIR or warped-FIR filters.

4.2. Second example

In this second example, a different loudspeaker is going to be equalized. It is composed of a 5 inch woofer in bass-reflex mode, and a 3/4 inch tweeter for the high frequencies. Its magnitude frequency response is displayed in thick line in Fig. 14 over the 0 dB level. In order to avoid excessive boosting at low frequencies the electro-acoustic target response has been selected as a fourth-order high-pass Butterworth at 75 Hz, and a second-order low-pass Butterworth at 18 kHz, and its magnitude is represented in thin line. The equalization obtained with $N_{MAC} = 250$ ($N_W = 33$, $N = 151$, and $\lambda = 0.96$) is shown centered over the -10 dB level. The error curve is always below ± 0.5 dB from 40 Hz to 20 kHz with a computational cost of only 250 MACs per sample.

4.3. Comparative example

To evaluate the benefits of the presented filter structure and design methodology, a comparison of the equalizations obtained with FIR, warped-FIR, and the proposed filter, has been carried out with the loudspeaker of the first example. The comparison has been done employing the same computational cost for the three filters, in this case 250 MACs per sample. The loudspeaker magnitude frequency response, the target response and the equalized responses are displayed in Fig. 15, scaled 10 dB for clarity. The respective error responses and $e_{\log-dB}$ values are shown in Fig. 16, with an original error value $e_{\log-dB} = 3.09$ dB.

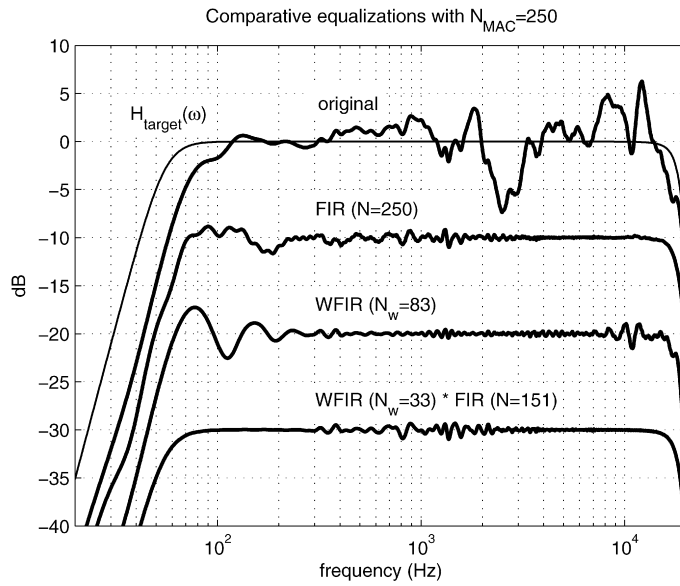

Fig. 15. Comparative of the achieved equalization for the same computational cost.

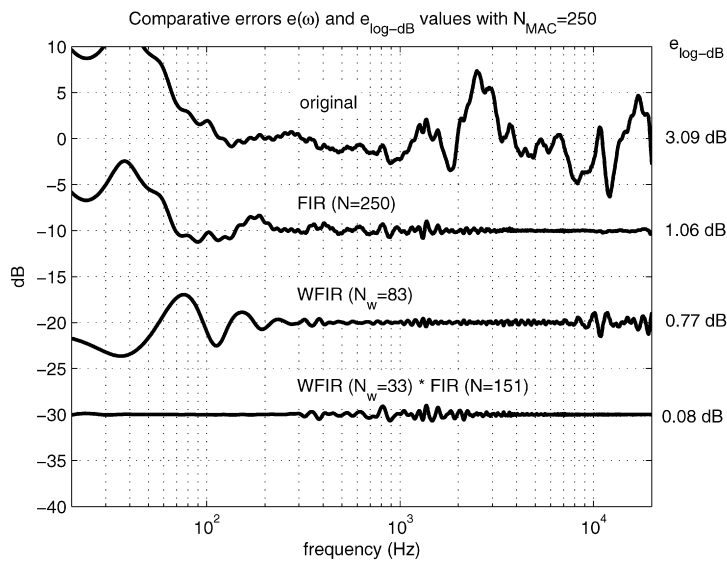

Fig. 16. Comparative error responses and e_{log-dB} values.

The FIR filter of order 250 is represented over the -10 dB level and achieves an equalization error curve within ± 1 dB from 200 Hz to 20 kHz, but at low frequencies the error reaches up to 7.5 dB at 40 Hz. The resulting error value is $e_{log-dB} = 1.06$ dB. The warped-FIR filter, displayed over the -20 dB level, has order $N_w = 83$, that corresponds to an equivalent order N_{MAC} of 250 (assuming a penalty of factor 3 of the warped filter implementation). In this case, the selected λ value is 0.76 in order to equalize the whole audio band, the maximum resolution of the filter being around 2 kHz. The error is now below ± 1 dB between 150 Hz and 10 kHz, but it is higher at lower and higher frequencies. The error value is better than with the FIR, $e_{log-dB} = 0.77$ dB. The equalization with the proposed filter structure is over the -30 dB level. It has an $N_{MAC} = 250$ with a warped-FIR filter of $N_w = 33$ with $\lambda = 0.98$, and a FIR filter of $N = 151$. The error curve is within ± 1 dB from 20 Hz to 20 kHz, and is even within ± 0.5 dB between 20 and 800 Hz and between 1.5 and 20 kHz. The error value is only $e_{log-dB} = 0.08$, indicating that from a psychoacoustic point of view, the perceived error will be the lower of the three filters. For the same computational cost, the proposed filter

obtains a more flat equalization and a lower error value, requiring then a lower order filter to achieve a desired error value in the equalization.

5. Conclusions

A new filter structure for loudspeaker equalization that requires low computational cost and has low latency has been presented. The filter structure is composed of two cascaded blocks that consists of a warped-FIR filter and a pure FIR filter. This structure looks to take advantage of each filter type and to obtain a frequency resolution of the filter that takes psychoacoustic aspects into account.

On the one hand, the FIR filter achieves an excellent resolution at high frequencies while having a simple structure, but at low frequencies, the resolution achieved is too poor and high order filters are necessary. On the other hand, the warped-FIR filter improves the frequency resolution at low and mid frequencies at the expense of losing resolution at high frequencies and increasing its complexity.

The proposed filter structure adequately combines the simplicity and high resolution of the FIR filter at high frequencies, and the advantages of the warped-FIR filter at low frequencies through the proper selection of the λ value. To maintain the low computational cost requirement, the order of the warped-FIR filter will be as low as possible to achieve an error in the equalization below a selected value (for example, ± 1 dB).

Different equalization examples with some loudspeakers have been carried out, comparing the performance of the proposed equalization method with pure FIR and warped-FIR filters. For the same computational cost, the proposed filter obtains an equalization that is more regular over the whole audio band, and has a lower value of the defined error function $e_{\log-dB}$ which considers psychoacoustic criteria in its evaluation. In other words, the proposed filter needs a lower order filter to achieve a defined error level on the equalization, saving huge amounts of computational cost compared to a pure FIR or pure warped-FIR filters topologies.

The proposed filter is designed using conventional FIR and warped-FIR filter design methods, apart from the correct selection of the λ value. Moreover, the structure of the filter is easy to implement in any digital signal processor (DSP) or microprocessor.

Acknowledgment

This work was supported by the Ministry of Education and Science of Spain under project TEC2006-13883-C04-01.

References

- [1] J.N. Mourjopoulos, Digital equalization of room acoustics, *J. Audio Eng. Soc.* 42 (11) (1994) 884–900.
- [2] U. Horbach, Design of high-quality studio loudspeaker using digital correction techniques, 109th Convention of the Audio Engineering Society, 2000.
- [3] W. Klippel, Compensation for nonlinear distortion of Horn loudspeakers by digital signal processing, *J. Audio Eng. Soc.* 44 (1996) 964–972.
- [4] J. Vanderkooy, D. Rife, Transfer-function measurement with maximum-length sequences, *J. Audio Eng. Soc.* 37 (6) (1989) 419–444.
- [5] A. Farina, Simultaneous measurement of impulse response and distortion with a swept-sine technique, 108th Convention of the Audio Engineering Society, 2000.
- [6] G. Ramos, J.J. López, Filter design method for loudspeaker equalization based on IIR parametric filters, *J. Audio Eng. Soc.* 54 (12) (2006) 1162–1178.
- [7] M. Karjalainen, E. Piirilä, A. Järvinen, J. Huopaniemi, Comparison of loudspeaker equalization methods based on DSP techniques, *J. Audio Eng. Soc.* 47 (1–2) (1999) 14–31.
- [8] R. Greenfield, M. Hawksford, Efficient filter design for loudspeaker equalization, *J. Audio Eng. Soc.* 39 (10) (1991) 739–751.
- [9] L.G. Johansen, P. Ruback, Target functions and preprocessing techniques in digital equalization design, 106th Convention of the Audio Engineering Society, 1999.
- [10] O. Kirkeby, P.A. Nelson, H. Hamada, F. Orduña-Bustamante, Fast deconvolution of multichannel systems using regularization, *IEEE Trans. Speech Audio Process.* 6 (1998) 189–194.
- [11] T. Parks, C.S. Burrus, *Digital Filter Design*, Wiley, New York, 1987.
- [12] J.O. Smith, J.S. Abel, Bark and ERB bilinear transform, *IEEE Trans. Speech Audio Process.* 7 (1999) 697–708.
- [13] M. Karjalainen, T. Paatero, Equalization of loudspeaker and room responses using Kautz filters: Direct least squares design, *EURASIP J. Adv. Signal Process.* (2007), doi:10.1155/2007/60949.
- [14] A.V. Oppenheim, R.W. Schaffer, *Discrete-Time Signal Processing*, Prentice Hall, Englewood Cliffs, NJ, 1989.
- [15] S.E. Olive, F.E. Toole, The detection of reflections in typical rooms, *J. Audio Eng. Soc.* 37 (7–8) (1989) 539–553.

- [16] S.J. Orfanidis, Introduction to Signal Processing, Prentice Hall, Englewood Cliffs, NJ, 1996.
- [17] F.E. Toole, S.E. Olive, The modification of timbre by resonances: Perception and measurement, *J. Audio Eng. Soc.* 36 (3) (1988) 122–142.
- [18] A.V. Oppenheim, D.H. Johnson, K. Steiglitz, Computation of spectra with unequal resolution using the fast Fourier transform, *Proc. IEEE* 89 (1971) 299–301.
- [19] H.W. Strube, Linear prediction on a warped frequency scale, *J. Acoust. Soc. Amer.* 68 (4) (1980) 1071–1076.
- [20] M. Karjalainen, A. Härmä, U.K. Laine, Realizable warped IIR filters and their properties, in: *Proceedings of ICASSP 97, 1997*, pp. 2205–2208.
- [21] A. Härmä, Implementation of frequency-warped recursive filters, *Elsevier Signal Process.* 80 (3) (2000) 543–548.
- [22] M. Tyril, J.A. Pedersen, P. Rubak, Digital filters for low-frequency equalization, *J. Audio Eng. Soc.* 29 (1–2) (2001) 36–43.



Germán Ramos was born in Valencia, Spain, in 1972. He received the M.S. degree in telecommunications engineering in 1997 and the Ph.D. degree in digital audio signal processing in 2006, both from the Technical University of Valencia, Spain. From 1999, he is a lecturer on DSP and electronics systems at the Electronic Department of the Universidad Politécnica de Valencia.

Over the last 10 years he has developed the software and hardware of several digital audio processors for professional audio companies from Spain, Germany, Portugal, Canada, and China, covering digital equalizers and cross-overs.

His research interests are in the areas of digital filter design and implementation, optimized in situ digital equalization of loudspeakers with low computational cost requirements, cross-over designs, dynamic-range compression, and wave-field synthesis.

He has done consultancy, algorithm and software development for Analog Device Inc. in DSP and audio applications.

He holds an international patent (patent pend) about the presented technology in a wider form, combining linear and non-linear digital filtering of any kind of filters (FIR, IIR) and structures (serial and parallel).

Dr. Ramos is a member of the AES and the IEEE.



José Javier López was born in Valencia, Spain, in 1969. He received the telecommunications engineering degree in 1992 and the Ph.D. degree in 1999, both from the Technical University of Valencia, Spain.

Since 1993 he has been involved in education and research in the Communications Department of the Technical University of Valencia, where at present he is an associate professor, teaching undergraduate and graduate courses on signal processing and digital audio processing.

His current research activity is centered on digital audio processing in the areas of 3D sound, wave field synthesis, acoustic spaces modeling with FDTD and DGW, efficient filtering structures for loudspeaker correction, algorithmics in signal processing, and development of multimedia software in real time.

He has published over 60 papers in international technical journals and at renowned conferences in the fields of audio and acoustics and has lead several research projects.

Dr. López was workshop co-chair at the 118th Convention of the Audio Engineering Society in Barcelona and has served on the committee of the AES Spanish Section for 5 years, at present as a secretary of the Section.



Basilio Pueo was born in Baleares, Spain, in 1973. He received the Bachelor and Master degrees in telecommunications engineering in 1997 and 2004, respectively. From 1999 up to the present, he was with the University of Alicante, Spain, in a teaching position.

He is currently pursuing the Ph.D. degree at the Technical University of Valencia, Spain, supervised by Dr. López. His main research interests include multichannel audio techniques and wave field synthesis, numerical methods in acoustic analysis and electroacoustic transduction.

In his fields of work he has published about 30 papers in international conferences and journals. He was papers co-chair of the 118th convention of the AES in Barcelona and chair of the 2006 AES Spanish Section Meeting. He has served as a member of the AES Spanish Section Committee, currently as a treasurer of the Section.